

## IGBT Discrete

$V_{CE}$	<b>650</b>	<b>V</b>
$I_C$	<b>50</b>	<b>A</b>
$V_{CE(SAT)} I_C=50A$	<b>1.60</b>	<b>V</b>

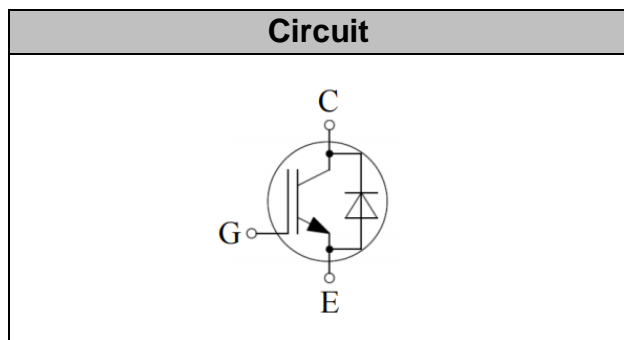

## Applications

- Solar converters
- Uninterruptible power supplies
- Welding converters
- Mid to high range switching frequency converters

## Features

- High speed smooth switching device for hard & soft switching
- Maximum junction temperature 175°C
- Positive temperature coefficient
- High ruggedness, temperature stable

## Maximum Ratings

Parameter	Symbol	Value	Unit
Collector-Emitter Breakdown Voltage	$V_{CE}$	650	V
DC Collector Current, limited by $T_{jmax}$ $T_C=25^\circ C$ value limited by bondwire $T_C=100^\circ C$	$I_C$	80 50	A
Diode Forward Current, limited by $T_{jmax}$ $T_C=25^\circ C$ value limited by bondwire $T_C=100^\circ C$	$I_F$	80 50	A
Continuous Gate-Emitter Voltage	$V_{GE}$	$\pm 20$	V
Transient Gate-Emitter Voltage ( $t_p \leq 10\mu s, D < 0.010$ )	$V_{GE}$	$\pm 30$	V
Turn off Safe Operating Area $V_{CE} \leq 650V$ , $T_j \leq 150^\circ C$		200	A
Pulsed Collector Current, $V_{GE}=15V$ , $t_p$ limited by $T_{jmax}$	$I_{CM}$	200	A
Diode Pulsed Current, $t_p$ limited by $T_{jmax}$	$I_{Fpuls}$	200	A
Power Dissipation, $T_j=175^\circ C, T_c=25^\circ C$	$P_{tot}$	283	W



Operating Junction Temperature	$T_j$	-40...+175	°C
Storage Temperature	$T_s$	-55...+150	°C
Soldering Temperature, wave soldering 1.6mm (0.063in.) from case for 10s		260	°C

### Electrical Characteristics of the IGBT ( $T_j = 25^\circ\text{C}$ unless otherwise specified):

Parameter	Symbol	Conditions	Min.	Typ.	Max.	Unit
<b>Static</b>						
Collector-Emitter Breakdown Voltage	$BV_{CES}$	$V_{GE}=0V, I_C=250\mu A$	650		-	V
Gate Threshold Voltage	$V_{GE(th)}$	$V_{GE}=V_{CE}, I_C=0.50mA$	3.0	4.0	5.0	V
Collector-Emitter Saturation Voltage	$V_{CE(sat)}$	$V_{GE}=15V, I_C=50A$ $T_j=25^\circ\text{C}$ , $T_j=125^\circ\text{C}$ $T_j=150^\circ\text{C}$	1.30	1.60 1.80 1.90	1.90	V
Zero Gate Voltage Collector Current	$I_{CES}$	$V_{CE}=650V, V_{GE}=0V$ $T_j=25^\circ\text{C}$ , $T_j=150^\circ\text{C}$			0.25 3.00	mA
Gate-Emitter Leakage Current	$I_{GES}$	$V_{CE}=0V, V_{GE}=\pm 20V$			100	nA

Parameter	Symbol	Conditions	Min.	Typ.	Max.	Unit
<b>Dynamic</b>						
Input Capacitance	$C_{ies}$	$V_{CE}=25V, V_{GE}=0V,$ $f=1MHz$	-	2.83	-	nF
Reverse Transfer Capacitance	$C_{res}$		-	0.02	-	
Gate Charge	$Q_G$	$V_{CC}=520V, I_C=50A,$ $V_{GE}=15V$	-	0.14	-	uC



## Electrical Characteristics of the Diode (T<sub>j</sub>= 25°C unless otherwise specified):

Parameter	Symbol	Conditions	Min.	Typ.	Max.	Unit
<b>Static</b>						
Diode Forward Voltage	V <sub>F</sub>	I <sub>F</sub> = 50A T <sub>j</sub> = 25°C, T <sub>j</sub> = 125°C T <sub>j</sub> = 150°C		1.60 1.50 1.40	2.00	V

## Switching Characteristic, Inductive Load

Parameter	Symbol	Conditions	Min.	Typ.	Max.	Unit
<b>Dynamic , at T<sub>j</sub>= 25°C</b>						
Turn-on Delay Time	t <sub>d(on)</sub>	V <sub>CC</sub> =400V, I <sub>C</sub> =50A, V <sub>GE</sub> = -5V~15V, R <sub>g</sub> =10Ω, Inductive Load	-	24	-	ns
Rise Time	t <sub>r</sub>		-	31	-	ns
Turn-on Energy	E <sub>on</sub>		-	2.05	-	mJ
Turn-off Delay Time	t <sub>d(off)</sub>		-	74	-	ns
Fall Time	t <sub>f</sub>		-	35	-	ns
Turn-off Energy	E <sub>off</sub>		-	0.36	-	mJ
Total switching energy	E <sub>ts</sub>		-	2.47	-	mJ
<b>Dynamic , at T<sub>j</sub>= 125°C</b>						
Turn-on Delay Time	t <sub>d(on)</sub>	V <sub>CC</sub> =400V, I <sub>C</sub> =50A, V <sub>GE</sub> = -5V~15V, R <sub>g</sub> =10Ω, Inductive Load	-	24	-	ns
Rise Time	t <sub>r</sub>		-	42	-	ns
Turn-on Energy	E <sub>on</sub>		-	2.11	-	mJ
Turn-off Delay Time	t <sub>d(off)</sub>		-	82	-	ns
Fall Time	t <sub>f</sub>		-	41	-	ns
Turn-off Energy	E <sub>off</sub>		-	0.44	-	mJ
Total switching energy	E <sub>ts</sub>		-	2.56	-	mJ
<b>Dynamic , at T<sub>j</sub>= 150°C</b>						
Turn-on Delay Time	t <sub>d(on)</sub>	V <sub>CC</sub> =400V, I <sub>C</sub> =50A, V <sub>GE</sub> = -5V~15V, R <sub>g</sub> =10Ω, Inductive Load	-	25	-	ns
Rise Time	t <sub>r</sub>		-	48	-	ns
Turn-on Energy	E <sub>on</sub>		-	2.19	-	mJ
Turn-off Delay Time	t <sub>d(off)</sub>		-	88	-	ns
Fall Time	t <sub>f</sub>		-	44	-	ns
Turn-off Energy	E <sub>off</sub>		-	0.47	-	mJ
Total switching energy	E <sub>ts</sub>		-	2.66	-	mJ



## Electrical Characteristics of the DIODE

Parameter	Symbol	Conditions	Min.	Typ.	Max.	Unit
<b>Dynamic , at T<sub>j</sub>= 25°C</b>						
Reverse Recovery Current	I <sub>rr</sub>	I <sub>F</sub> =50A, V <sub>R</sub> =400V -di/dt=450A/μs,	-	15	-	A
Reverse Recovery Charge	Q <sub>rr</sub>		-	1.58	-	uC
Diode reverse recovery time	t <sub>rr</sub>		-	148	-	ns
Reverse Recovery Energy	E <sub>rec</sub>		-	0.29	-	mJ
<b>Dynamic , at T<sub>j</sub>= 125°C</b>						
Reverse Recovery Current	I <sub>rr</sub>	I <sub>F</sub> =50A, V <sub>R</sub> =400V -di/dt=450A/μs,	-	21	-	A
Reverse Recovery Charge	Q <sub>rr</sub>		-	2.54	-	uC
Diode reverse recovery time	t <sub>rr</sub>		-	183	-	ns
Reverse Recovery Energy	E <sub>rec</sub>		-	0.65	-	mJ
<b>Dynamic , at T<sub>j</sub>= 150°C</b>						
Reverse Recovery Current	I <sub>rr</sub>	I <sub>F</sub> =50A, V <sub>R</sub> =400V -di/dt=450A/μs,	-	24	-	A
Reverse Recovery Charge	Q <sub>rr</sub>		-	3.59	-	uC
Diode reverse recovery time	t <sub>rr</sub>		-	218	-	ns
Reverse Recovery Energy	E <sub>rec</sub>		-	0.79	-	mJ

## Thermal Resistance

Parameter	Symbol	Max. Value	Unit
IGBT Thermal Resistance, Junction - Case	R <sub>th(j-c)</sub>	0.53	K/W
Diode Thermal Resistance, Junction - Case	R <sub>th(j-c)</sub>	1.05	K/W
Thermal Resistance, Junction - Ambient	R <sub>th(j-a)</sub>	40	K/W

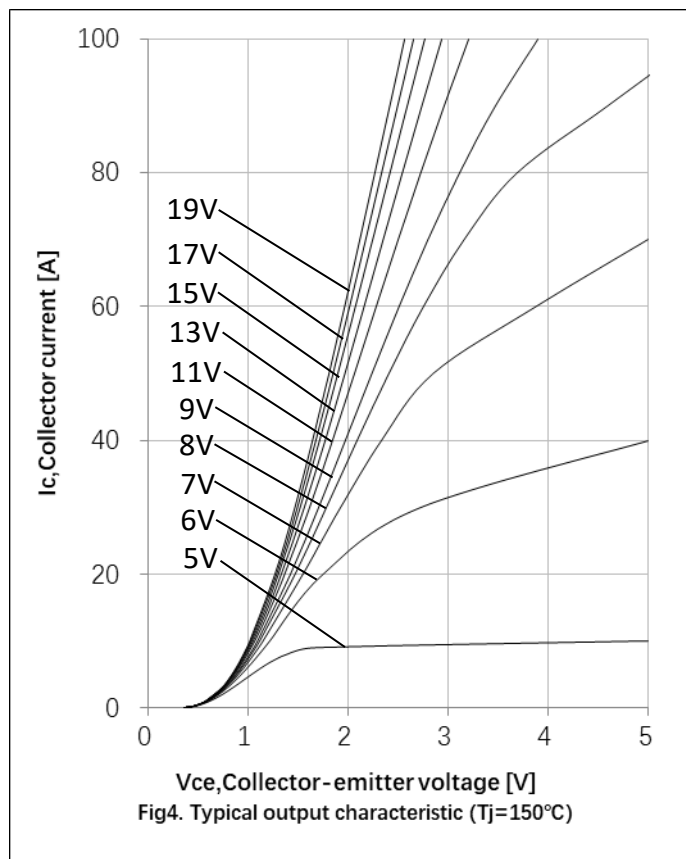
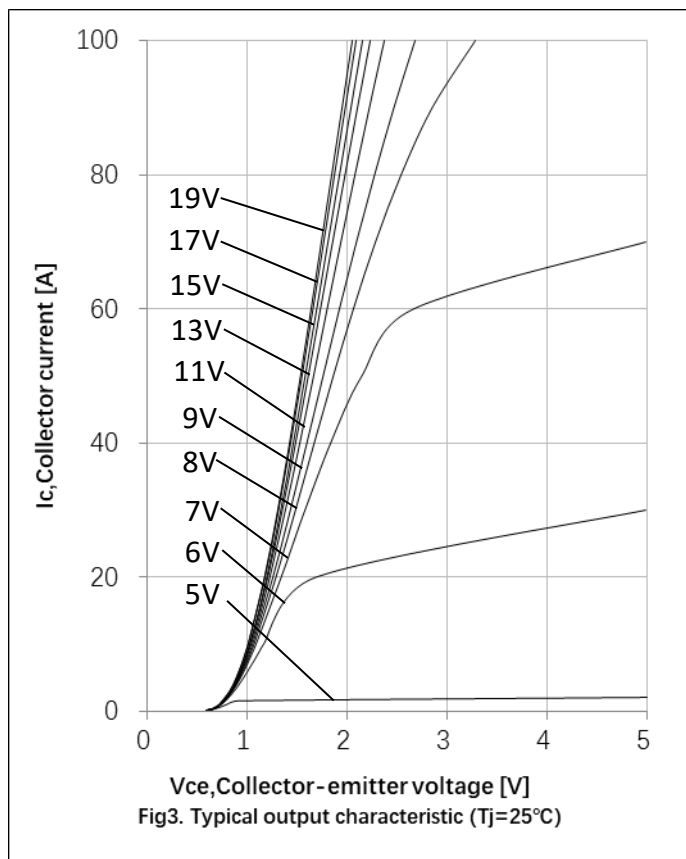
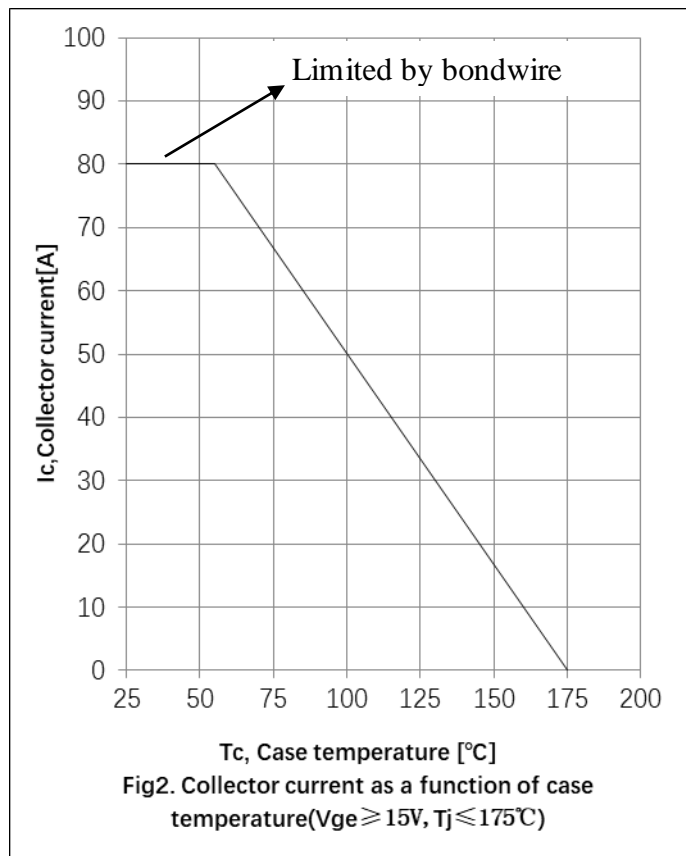
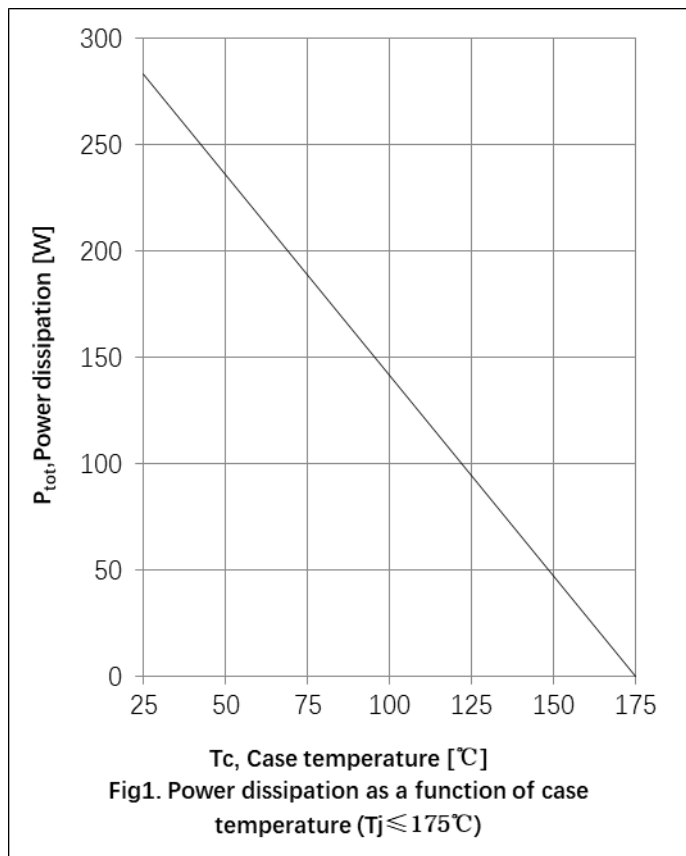

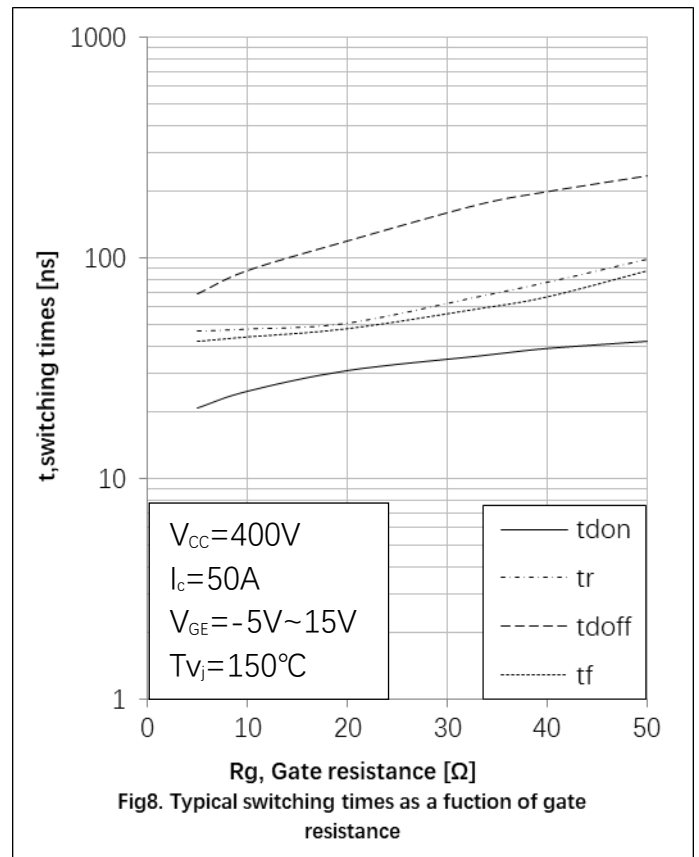
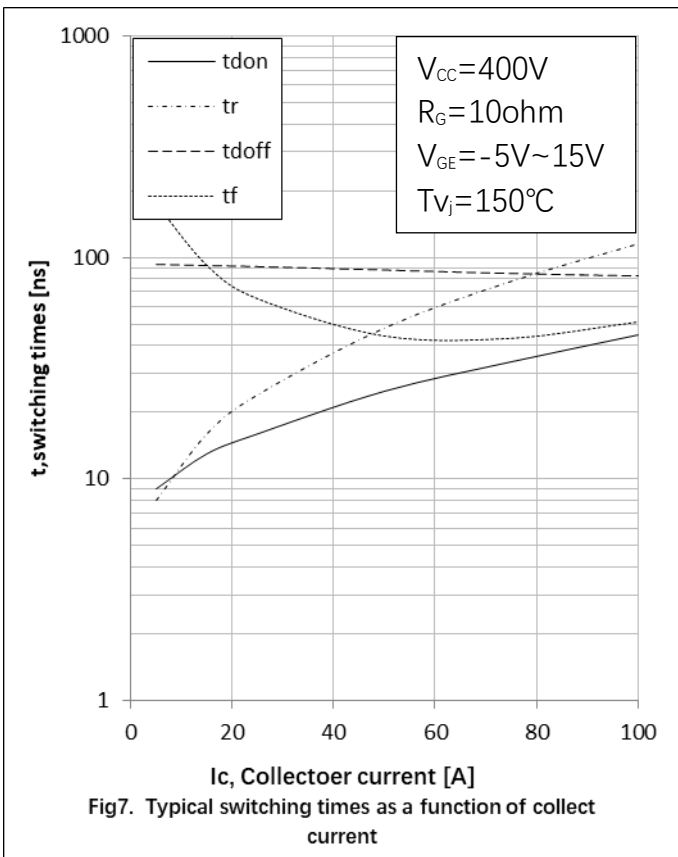
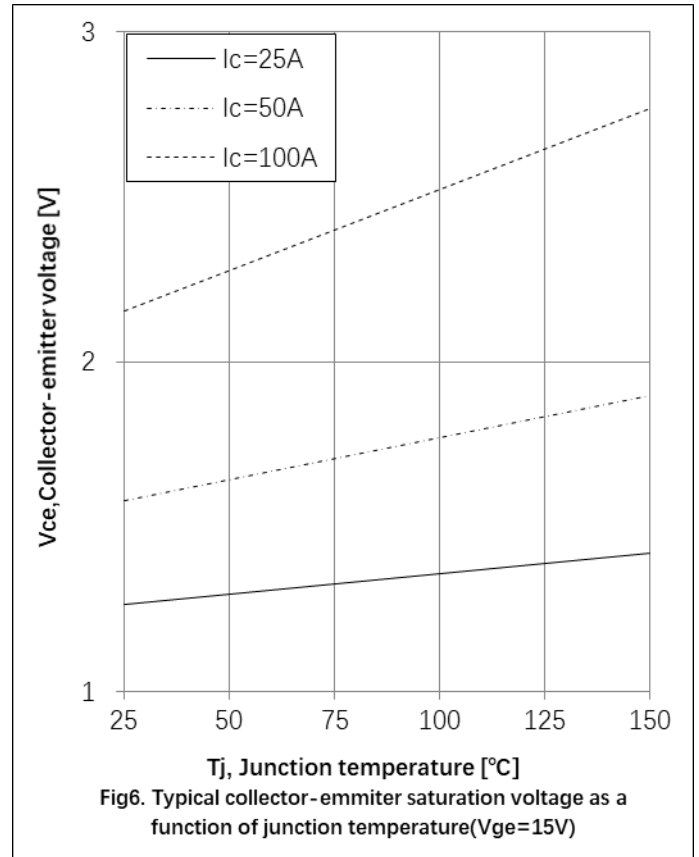
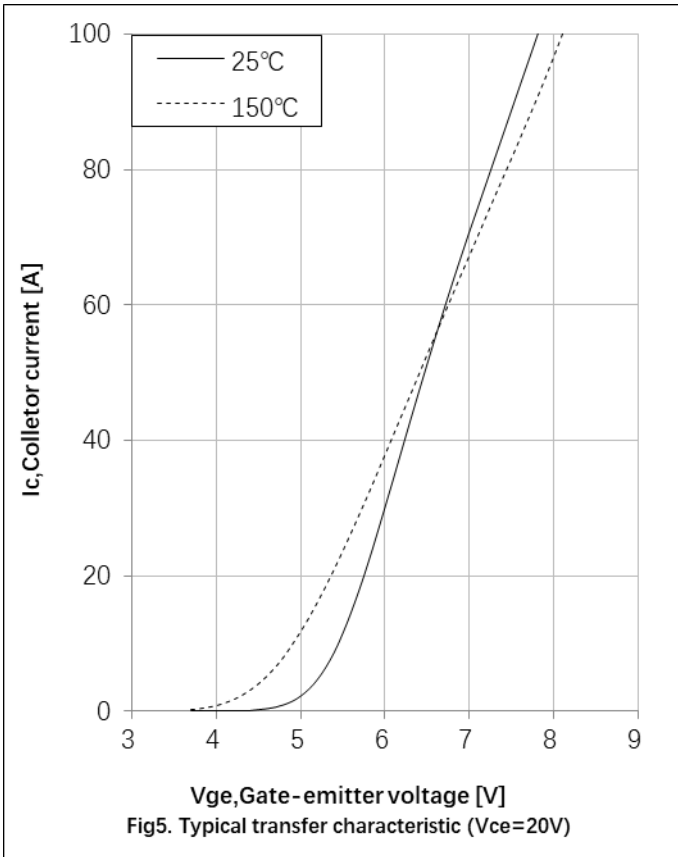

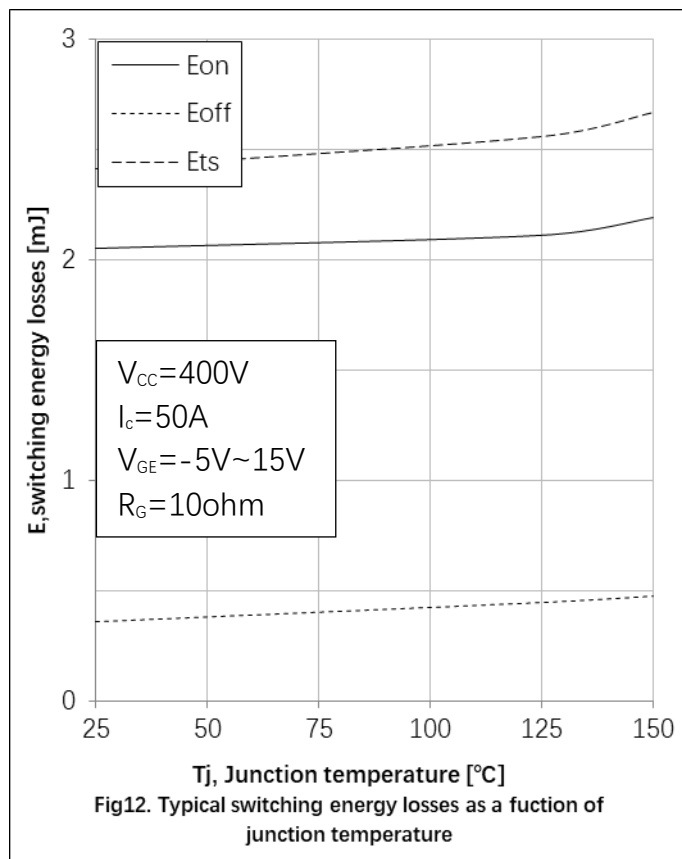
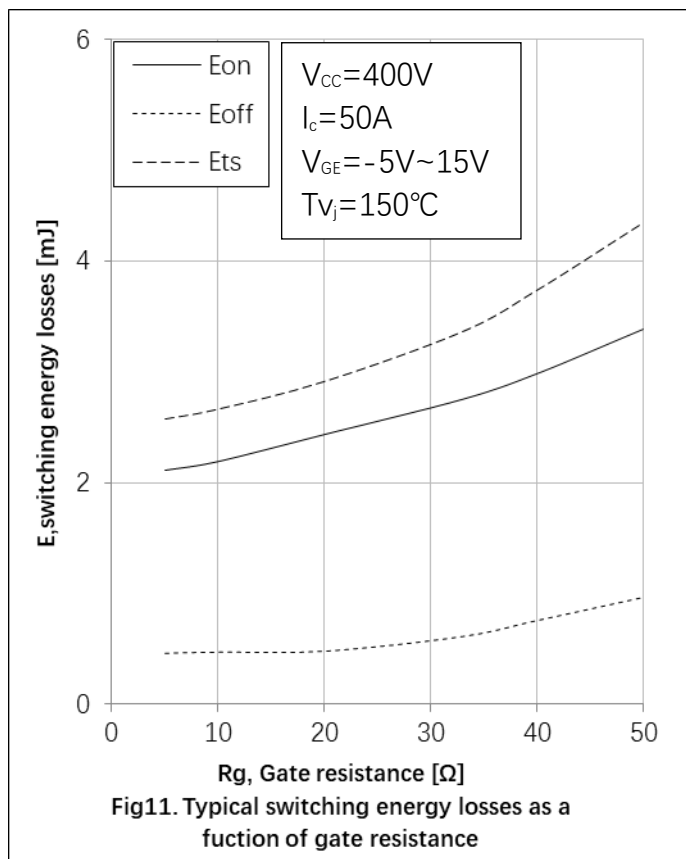
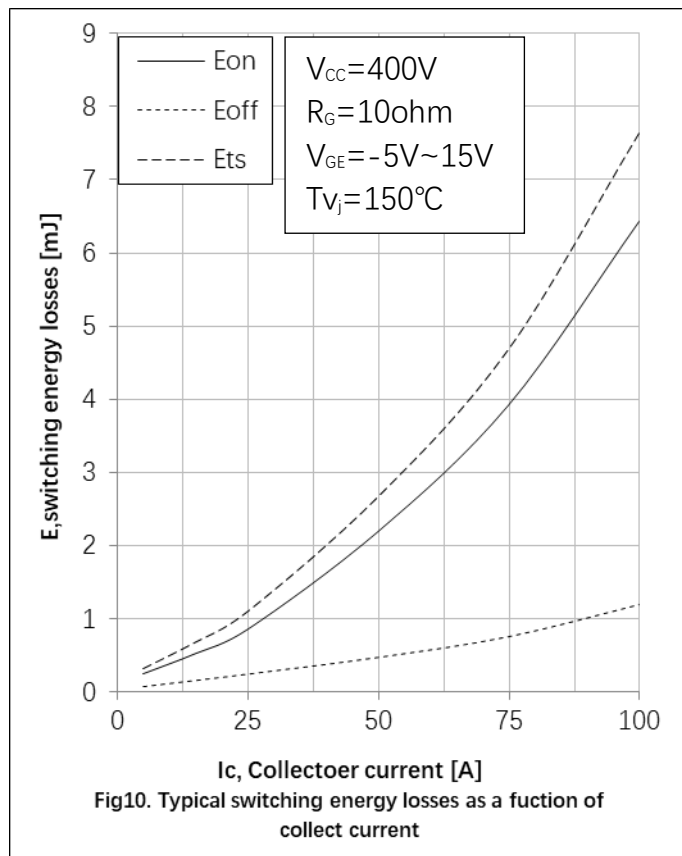
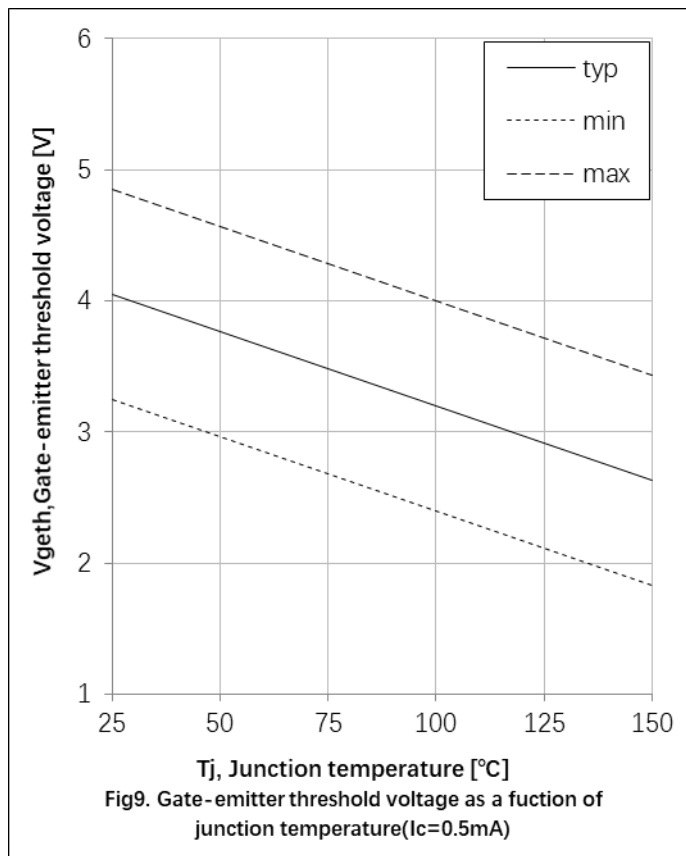

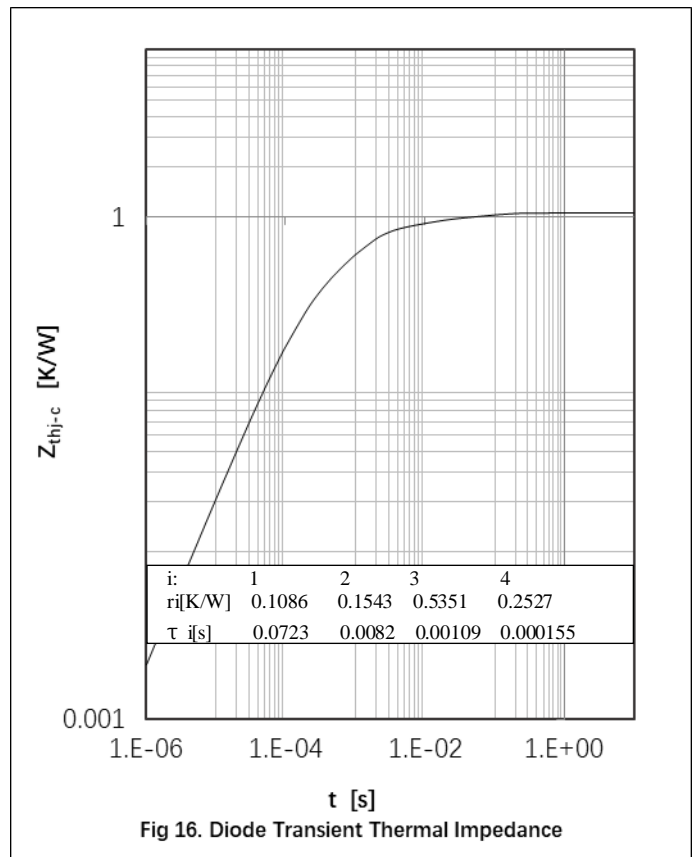
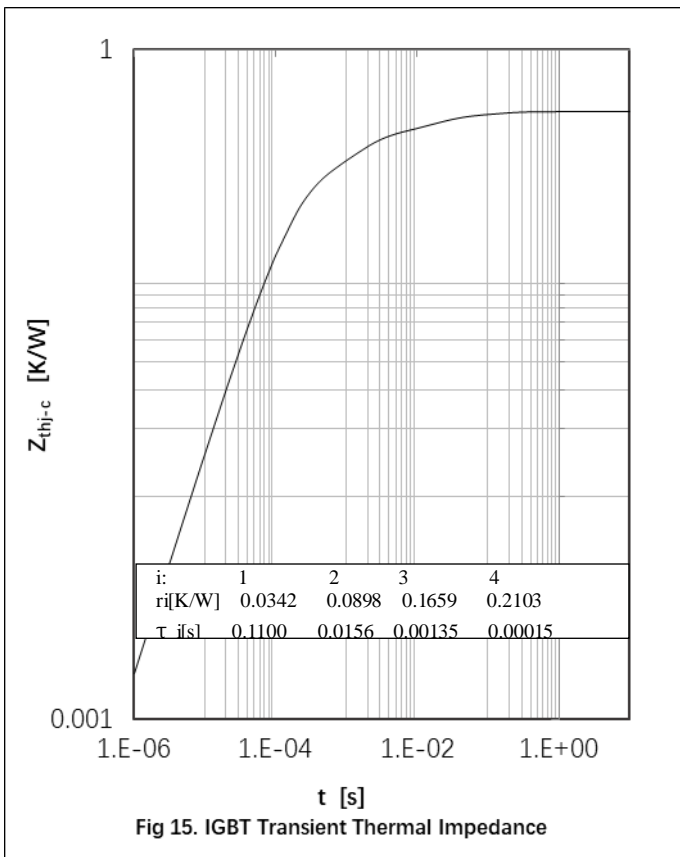
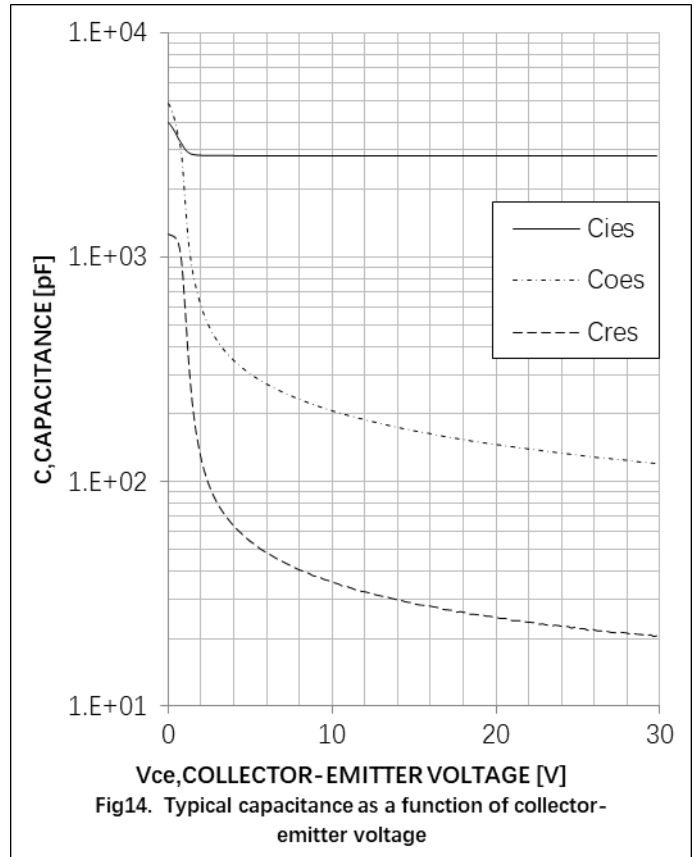
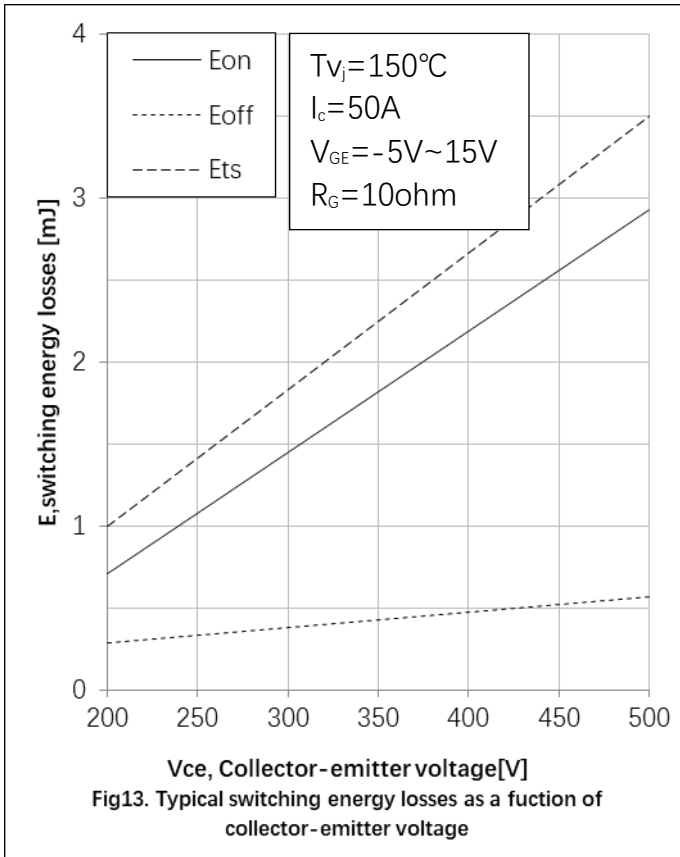



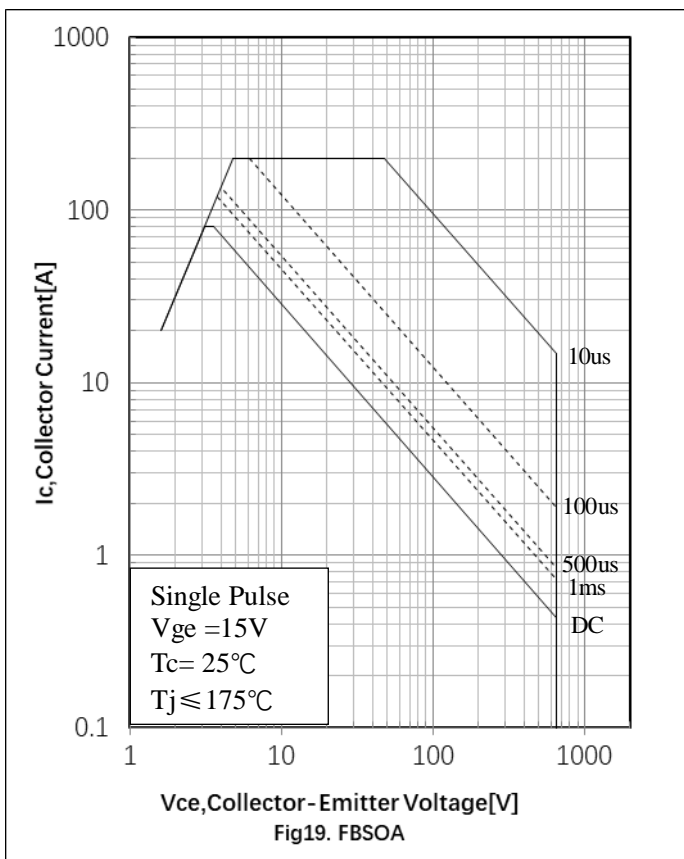
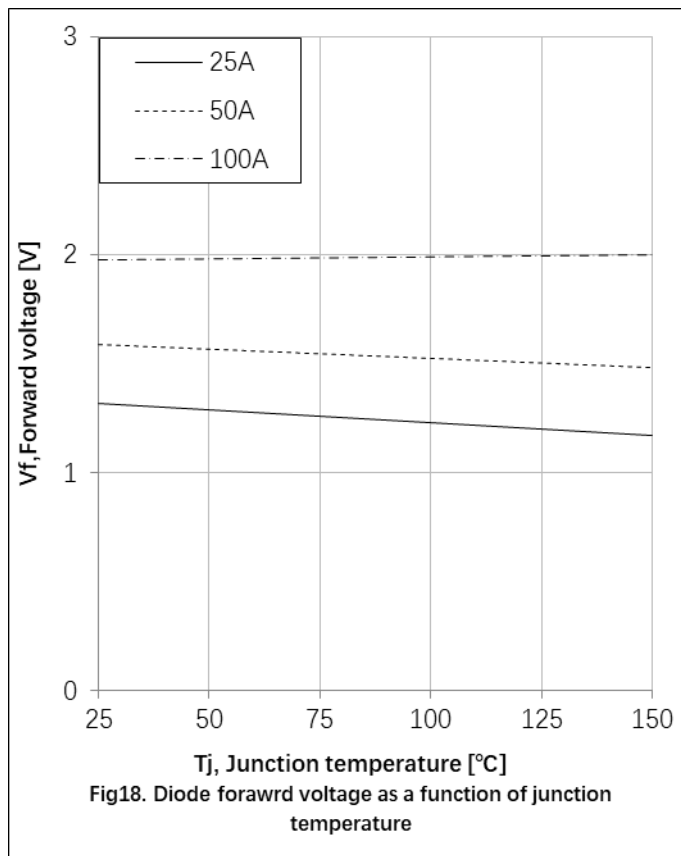
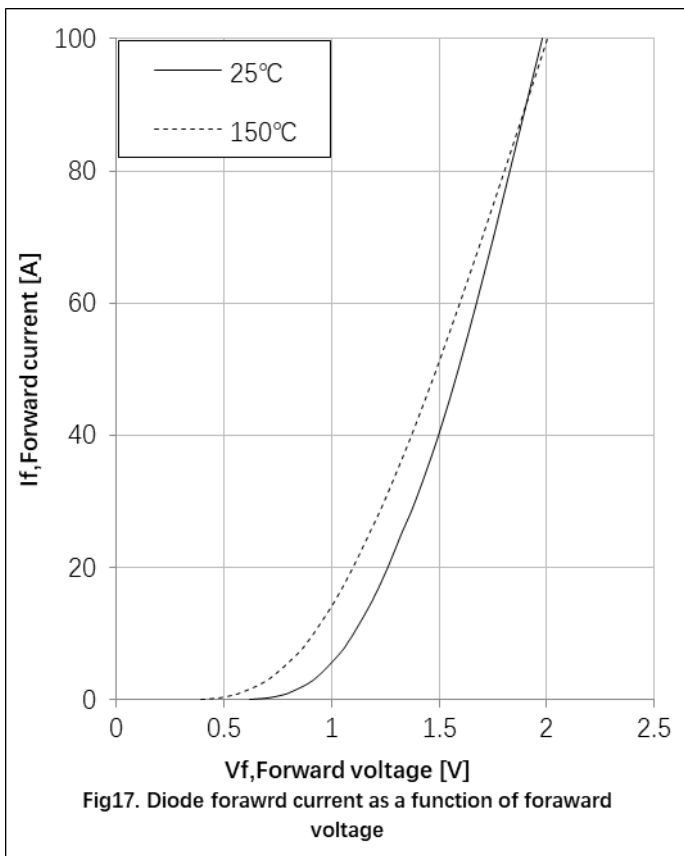

## ● Circuit Diagram

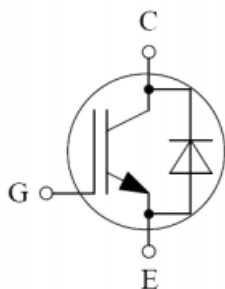

## ● Package Outline Information

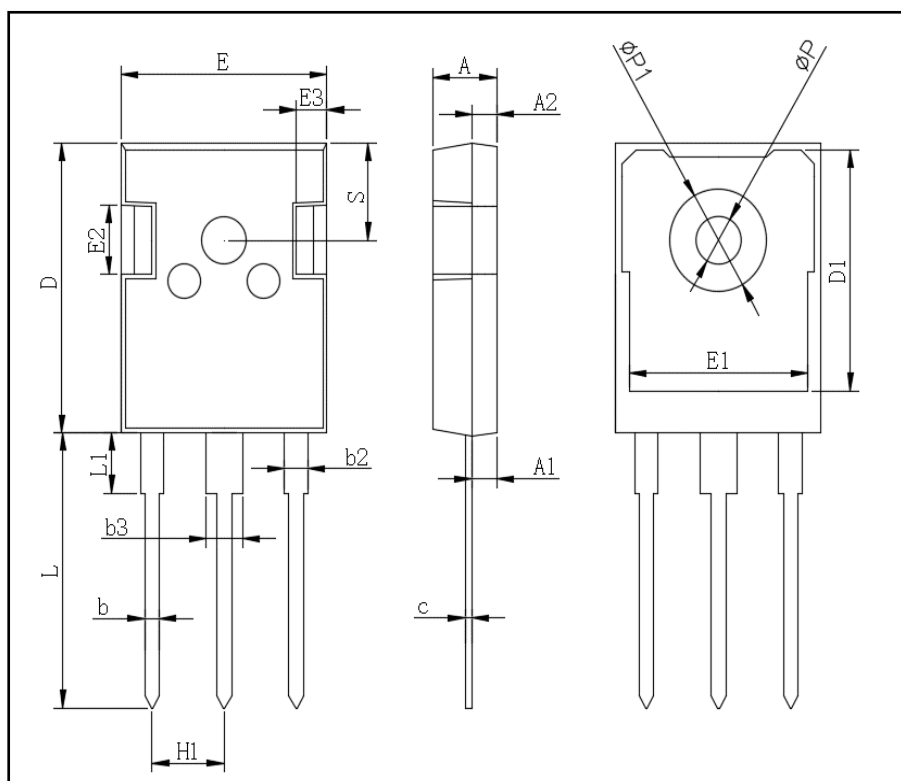

TO-247AB		
Dim	Min	Max
A	4.80	5.20
A1	2.21	2.61
A2	1.85	2.15
b	1.0	1.4
b2	1.91	2.21
C	0.5	0.7
D	20.70	21.30
D1	16.25	16.85
E	15.50	16.10
E1	13.0	13.6
E2	4.80	5.20
E3	2.30	2.70
L	19.62	20.22
L1	-	4.30
Φ P	3.40	3.80
Φ P1	-	7.30
S	6.15TYP	
H1	5.44TYP	
b3	2.80	3.20



ISSUE	REVISION	DATE
1.0	Add Datasheet	8-Oct-23

## Marking Information

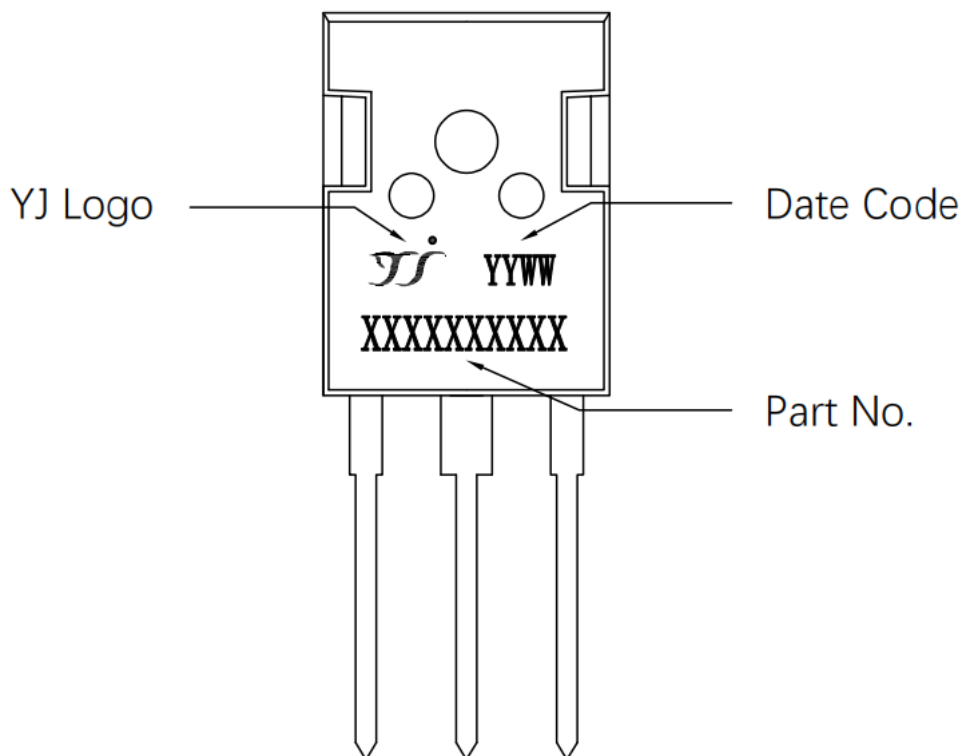

## Package Parameters

Base Part Number	Package Type	Standard Pack		Orderable Part Number
		Form	Quantity	
DGW50N65CTH2A	TO-247	Tube	30	DGW50N65CTH2A

