



FRED Modules

V_{RRM} 1200V

I_{FAV} 200 A

Applications

- Inversion Welder
- Uninterruptible Power Supply (UPS)
- Plating Power Supply
- Ultrasonic Cleaner and Welder
- Power Factor Correction (PFC) Circuit
- Converter & Chopper

Features

- Soft Reverse Recovery Characteristics
- Ultrafast Reverse Recovery Time
- Low Reverse Recovery Loss
- Low Forward Voltage
- High Surge Current Capability
- Low Inductance Package

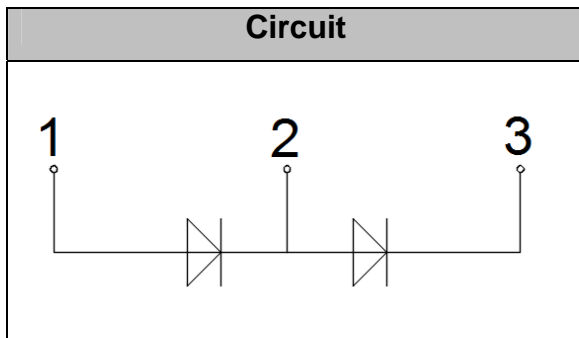

Maximum Ratings

Symbol	Conditions	Values	Units
V_R		1200	V
V_{RRM}		1200	V
$I_{F(AV)}$	$T_C=110^{\circ}\text{C}$, Per Diode	200	A
$I_{F(RMS)}$	$T_C=110^{\circ}\text{C}$, Per Diode	280	A
I_{FSM}	1/2 Cycle, 50Hz, Sine	1800	A
	1/2 Cycle, 60Hz, Sine	1950	A
I^2t	$T_J=45^{\circ}\text{C}$, $t=10\text{ms}$, 50Hz, Sine	16200	A^2s
	$T_J=45^{\circ}\text{C}$, $t=8.3\text{ms}$, 60Hz, Sine	19000	A^2s
P_D		568	W
Visol	AC, $T_{on}=1\text{min}$	3000	V
T_J		-40 to +150	$^{\circ}\text{C}$
T_{STG}		-40 to +125	$^{\circ}\text{C}$
Torque	Recommended (M6)	4.5	N·m
Torque	Recommended (M6)	4.5	N·m
Weight		160	g

Thermal Characteristics

Symbol	Conditions	Values	Units
$R_{th(j-c)}$	Junction-to-Case	0.22	$^{\circ}\text{C}/\text{W}$



Electrical Characteristics

Symbol	Conditions	Values			Units
		Min.	Typ.	Max.	
I_{RM}	$V_R=1200V$	--	--	1	mA
	$V_R=1200V, T_J=125^\circ C$	--	--	5	mA
V_F	$I_F=200A$	--	2.3		V
	$I_F=200A, T_J=125^\circ C$	--	1.9		V
t_{rr}	$I_F=1A, V_R=30V, di_F/dt=-200A/\mu s$	--	57	--	ns
t_{rr}	$V_R=600V, I_F=200A, di_F/dt=-200A/\mu s, T_J=25^\circ C$	--	110	--	ns
I_{RRM}		--	9	--	A
t_{rr}	$V_R=600V, I_F=200A, di_F/dt=-200A/\mu s, T_J=125^\circ C$	--	500	--	ns
I_{RRM}		--	21	--	A

Performance Curves

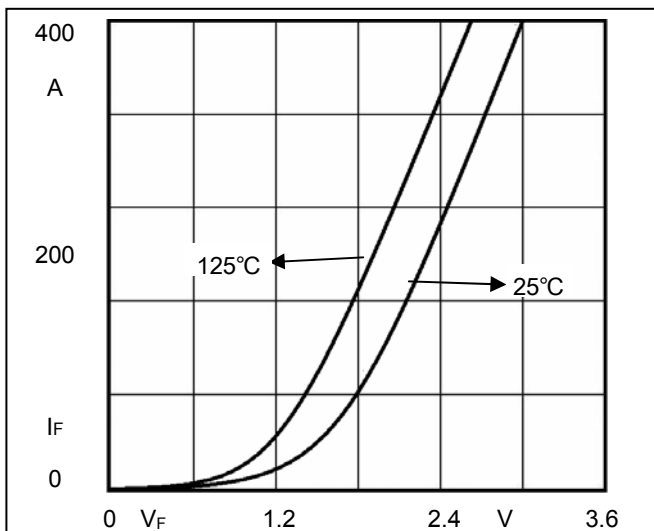

Fig1. Forward Voltage Drop vs Forward Current

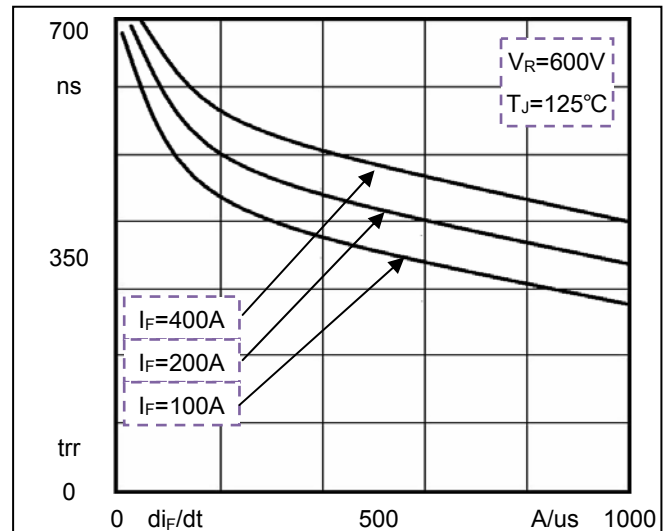

Fig2. Reverse Recovery Time vs di_F/dt

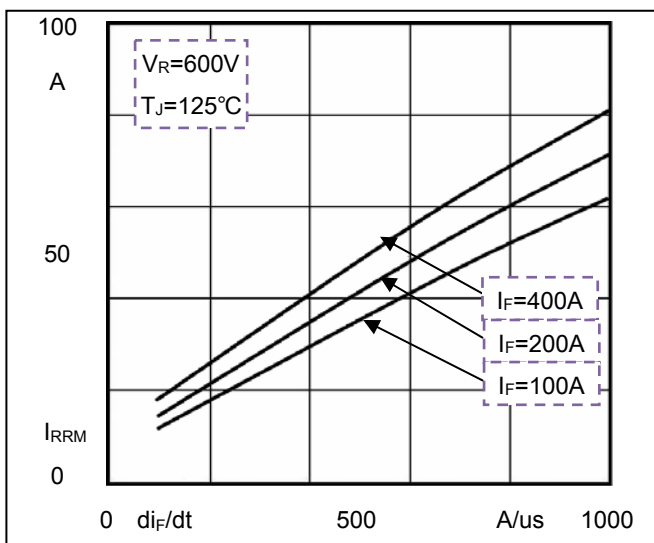

Fig3. Reverse Recovery Current vs di_F/dt

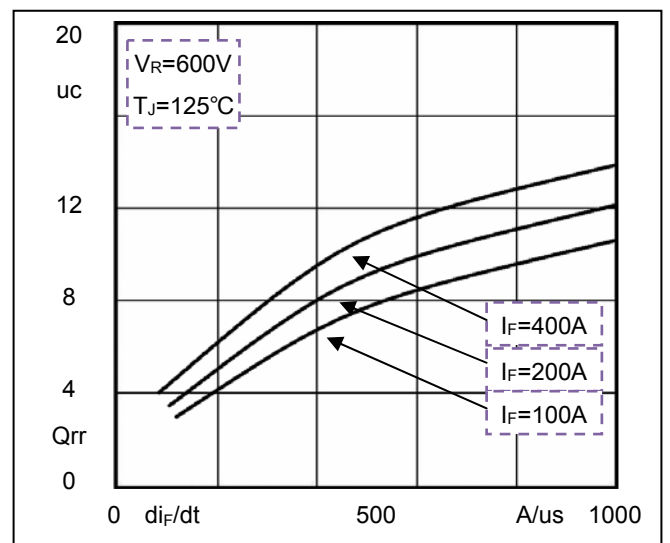
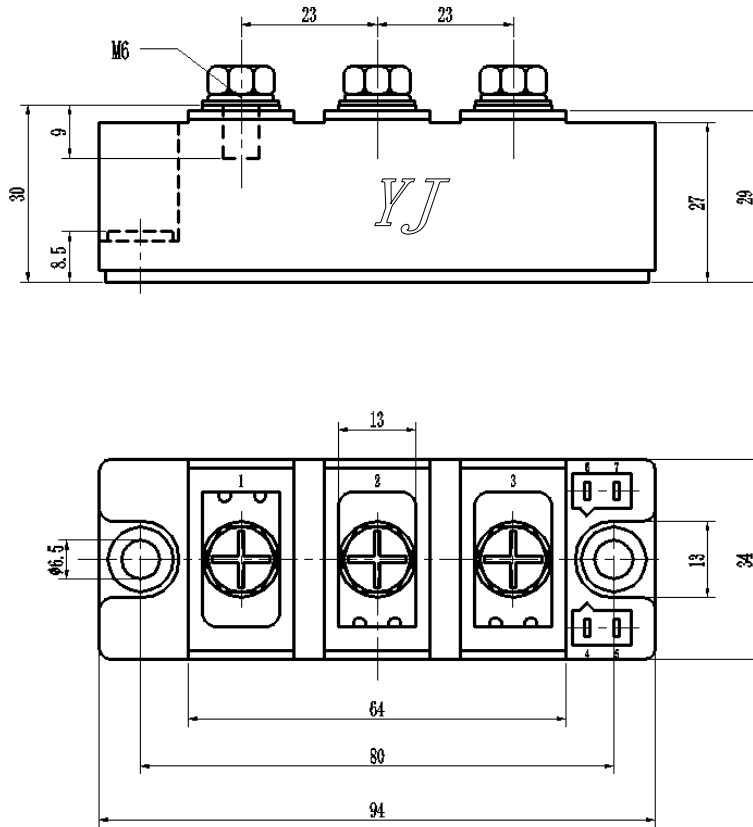

Fig4. Reverse Recovery Charge vs di_F/dt

Package Outline Information

CASE: F2N



Dimensions in mm